

CP

LAB

5 MM

per realizzare inedite  
soluzioni di design

DESIGN



SINCE 1982

CP

LAB

5 MM

per realizzare inedite  
soluzioni di design

5 MM for exploring unusual design solution

DESIGN



SINCE 1982

# L'ESSENZA DEL DESIGN/ THE ESSENCE OF DESIGN

Dare forma alle idee è un processo appassionante, magico e geniale. Lasciati accompagnare in questo entusiasmante percorso creativo dal materiale più straordinario che la natura ci ha dato.

Il legno è materia viva e vitale, innovativa e tradizionale, sostenibile e futuribile. È la sostanza di cui sono fatti i sogni./

Making ideas take shape is an exciting, magic and ingenious process. Let yourself go in this thrilling creative adventure with the most extraordinary material nature has given us.

Wood is living, vital matter, innovative and traditional, sustainable and lasting into the future. It is the stuff dreams are made of.

CPLAB DESIGN



CAMBIA IL MODO  
DI PROGETTARE:  
IN 5 MM/  
CHANGE YOUR WAY  
OF DESIGNING:  
IN 5 MM

Lo strato di 5 mm di legno nobile, lo stesso impiegato per realizzare i nostri parquet, può essere utilizzato per dare una nuova esclusiva veste ad ogni tuo progetto. Riesci a immaginarlo?/

The 5mm layer of solid wood used for our wood flooring can give a new, exclusive look to all your projects. Can you imagine?

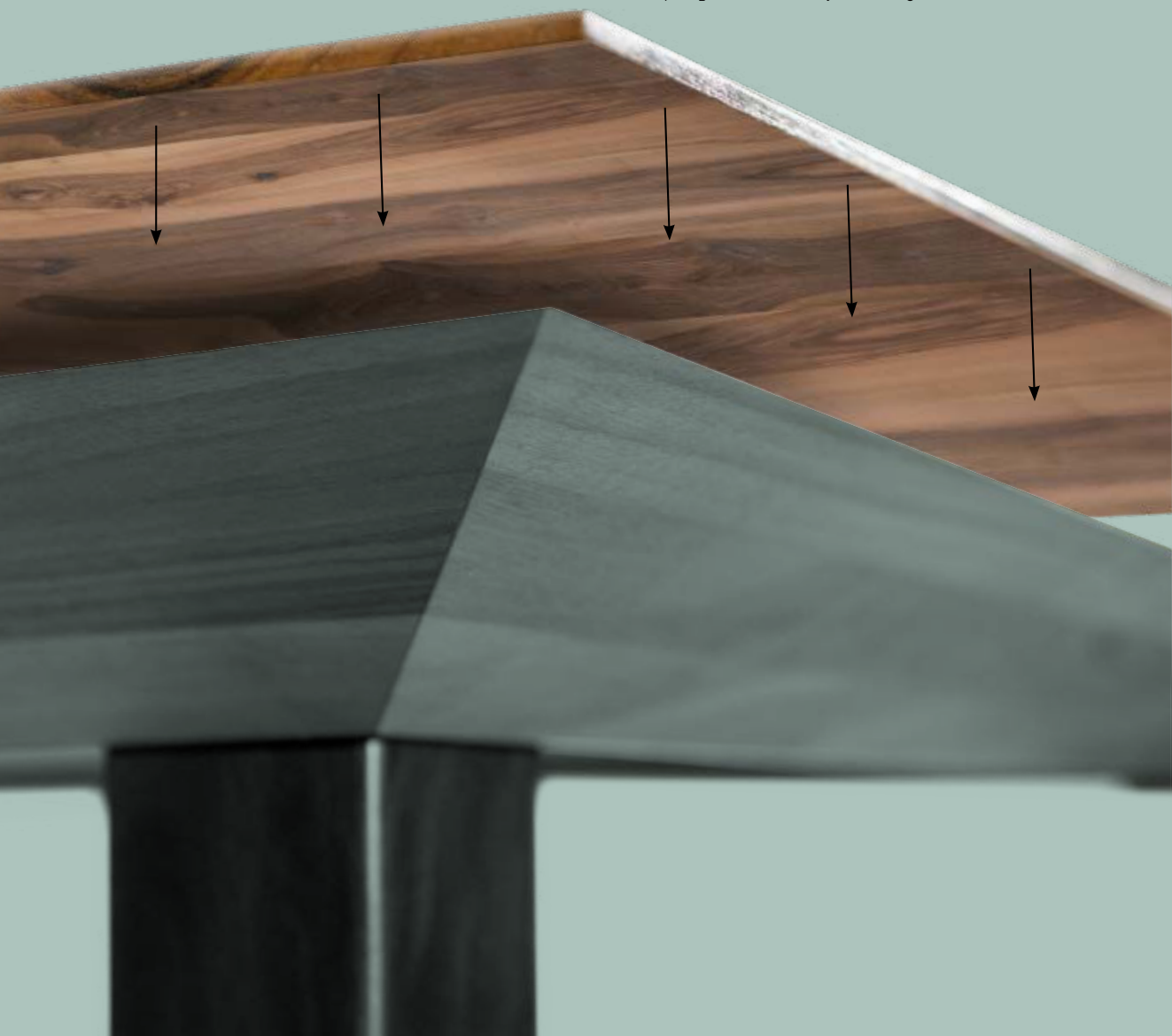

## COSA/WHAT

CP Lab Design è un laboratorio creativo dedicato ai progettisti, nato per sperimentare le infinite possibilità espressive che lo strato di 5 mm di legno può offrire. Ridefiniamo assieme il concetto classico di parquet: dal pavimento al complemento. La natura del CP Lab è andare oltre il pavimento in legno per sviluppare una nuova ricerca estetica, con inedite soluzioni nei complementi d'arredo./

CP Lab Design is a creative laboratory dedicated to designers, set up to experiment the infinite artistic possibilities provided by a 5 mm layer of wood. Together we re-define the classical concept of wooden boards: from flooring to complementary decor items. The idea behind CP Lab is to go beyond wood floorboards and develop original solutions for décor items featuring new aesthetics.

## COME/HOW

Condividere la nostra profonda conoscenza del legno e il know how tecnologico nella costruzione di parquet a 3 strati permette di dare concretezza alle idee e trasformarle in ambiziosi progetti, realizzabili su misura./

By sharing our profound knowledge of wood and technological know-how in creating three-layer wood flooring we help ideas take shape and transform them into ambitious projects for made to measure solutions.

## PERCHÉ/WHY

Attraverso la preziosa collaborazione con architetti, progettisti e designer è più semplice pensare fuori dagli schemi e trovare intuizioni originali, da plasmare con le più prestigiose specie legnose./

Valuable cooperation with architects, planners and designers makes it easier to think outside the box and come up with original ideas to model with the most important types of wood.

5 mm



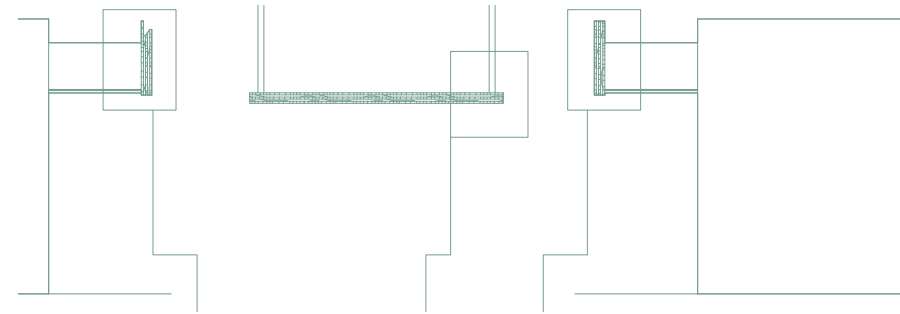

## DIAMO FORZA ALLA BELLEZZA/ THE POWER OF BEAUTY

Il design delle ante e dei mobili nasce da 5 strati incrociati: il fascino della pregiata essenza legnosa a vista su entrambe le facce incontra la stabilità e la solidità delle lamelle interne in multistrato di legno./

The design of the doors and cabinets features 5 crossed layers: the charm of the outstanding wood species visible on both sides goes hand in hand with the stable, robust internal plywood slats.

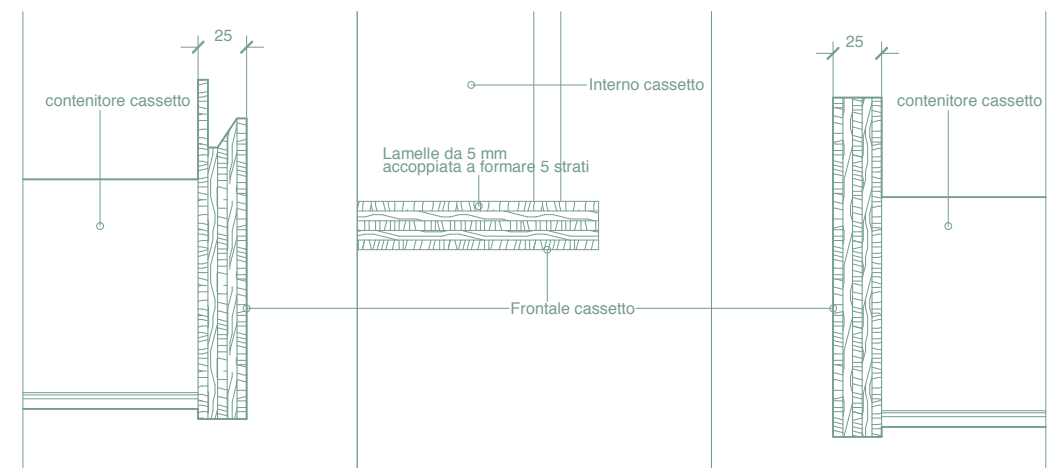
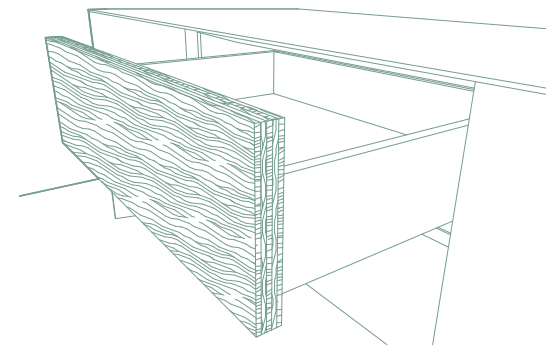

INSIEME CERCHIAMO  
NUOVE SOLUZIONI  
COSTRUTTIVE/  
TOGETHER WE SEEK NEW SOLUTIONS

La struttura a tre strati del  
parquet è il perfetto mix di  
bellezza, flessibilità e stabilità./

The three-layer structure of wood  
flooring is a perfect mix of beauty,  
flexibility and stability.

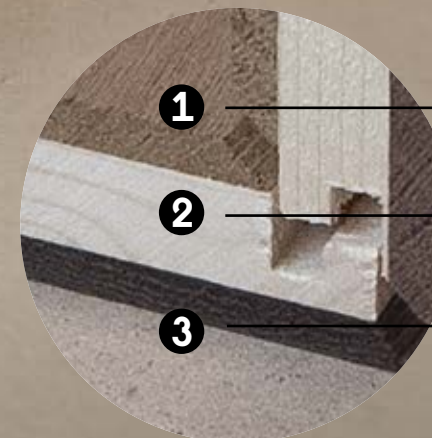
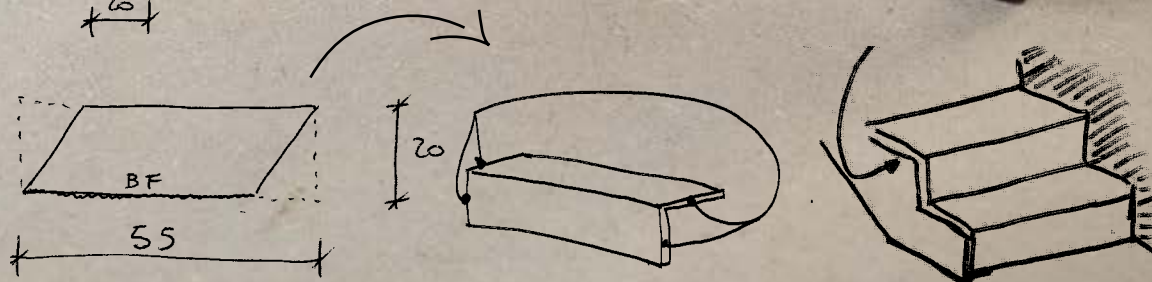
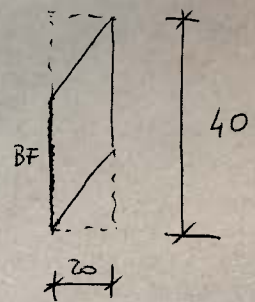
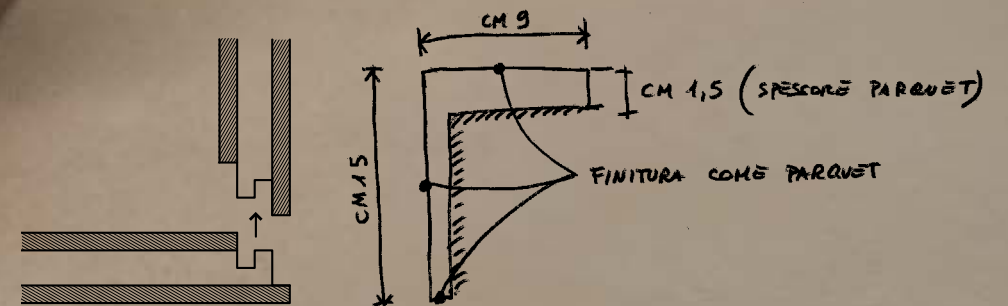

Lo strato nobile a  
vista di 5 mm, mette  
in risalto la grande  
qualità estetica del  
vero legno.

The 5mm layer of solid  
wood displays the  
fantastic aesthetic  
effect of real wood.

Una possente anima  
centrale in listellare  
di abete definisce  
gli importanti  
spessori.

A robust fir board  
core defines important  
thickness.

La controbilanciatura,  
realizzata con la  
stessa specie legnosa  
dello strato nobile,  
garantisce massima  
stabilità nel tempo.

The backing, in the  
same wood as the top  
layer, ensures great  
stability over time.

A modern interior space, likely a bathroom or dressing area, featuring a wooden vanity with a mirror and a herringbone wood floor. The vanity is made of dark wood and has a white countertop. On the counter, there is a small framed picture, a white soap dish, and a silver faucet. The floor is made of dark wood in a herringbone pattern. In the background, there is a glass partition and a wooden stool with a folded piece of clothing on it. The lighting is warm and focused on the vanity and floor.

CP LAB DESIGN  
DAL PAVIMENTO  
AL COMPLEMENTO/  
CP LAB DESIGN  
NOT JUST FLOORING,  
ALSO COMPLEMENTARY ITEMS

# 1 DIAMO FORMA ALLA COLLABORAZIONE/ WE GIVE SHAPE TO COOPERATION

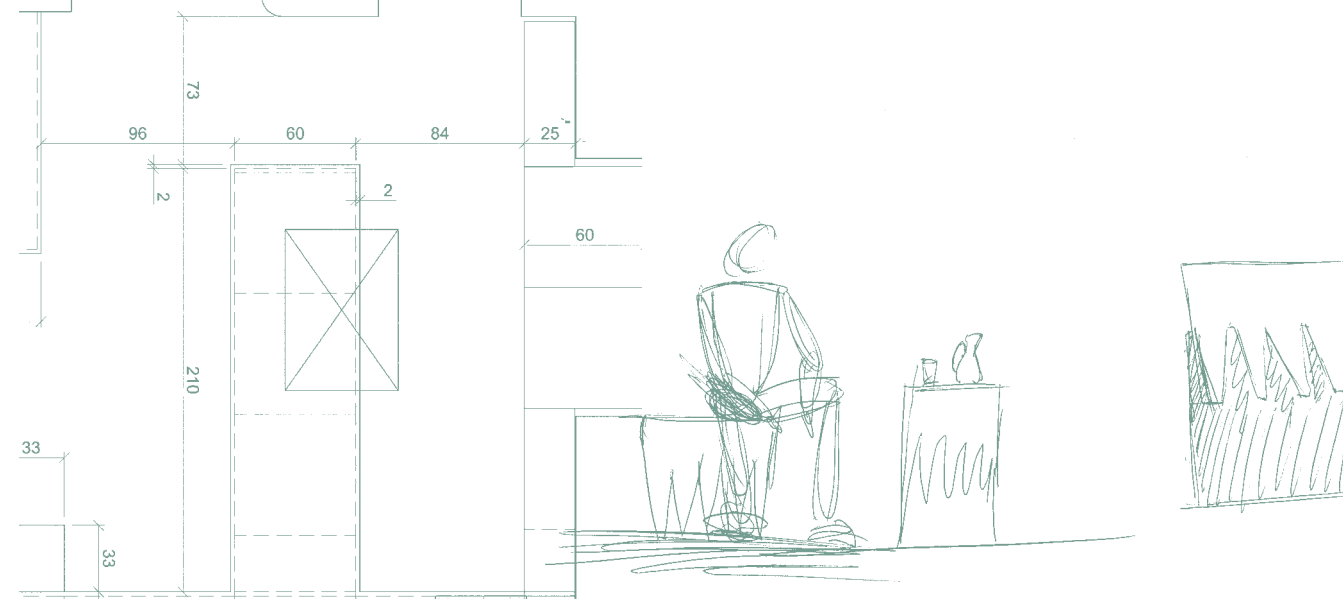
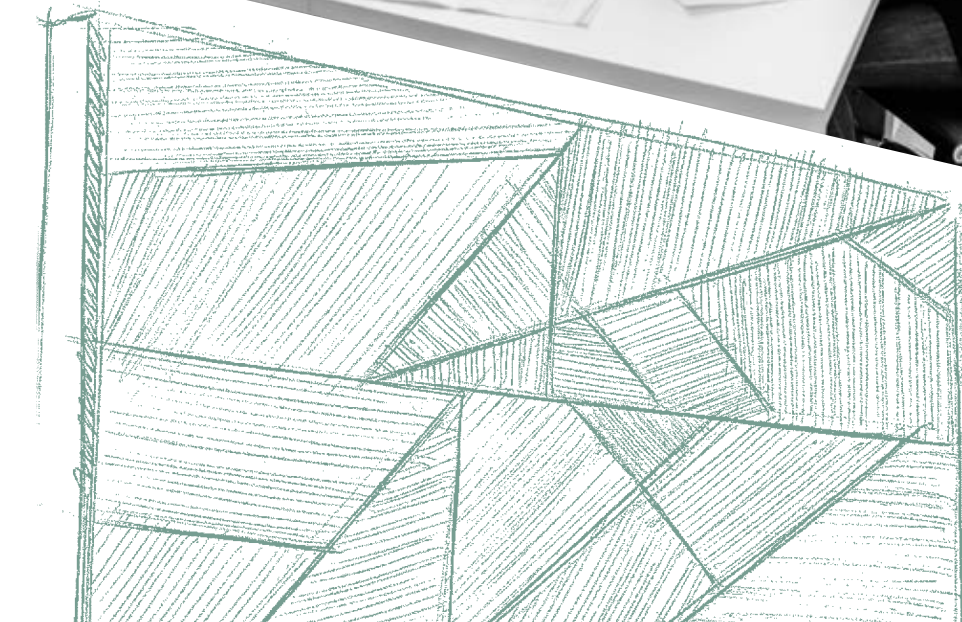

Sentiti finalmente libero di esprimere la tua creatività: di scegliere formati e colori fuori dall'ordinario per rivestimenti e complementi, di ideare ambienti personalizzati di grande fascino dove tutto è coordinato, di dare forma a esclusivi arredi di design unici./

At last you can feel free to express your creativity: to choose out of the ordinary formats and colours for cladding and complementary items, and create fascinating customised rooms where everything is coordinated with exclusive, unique designer décor.

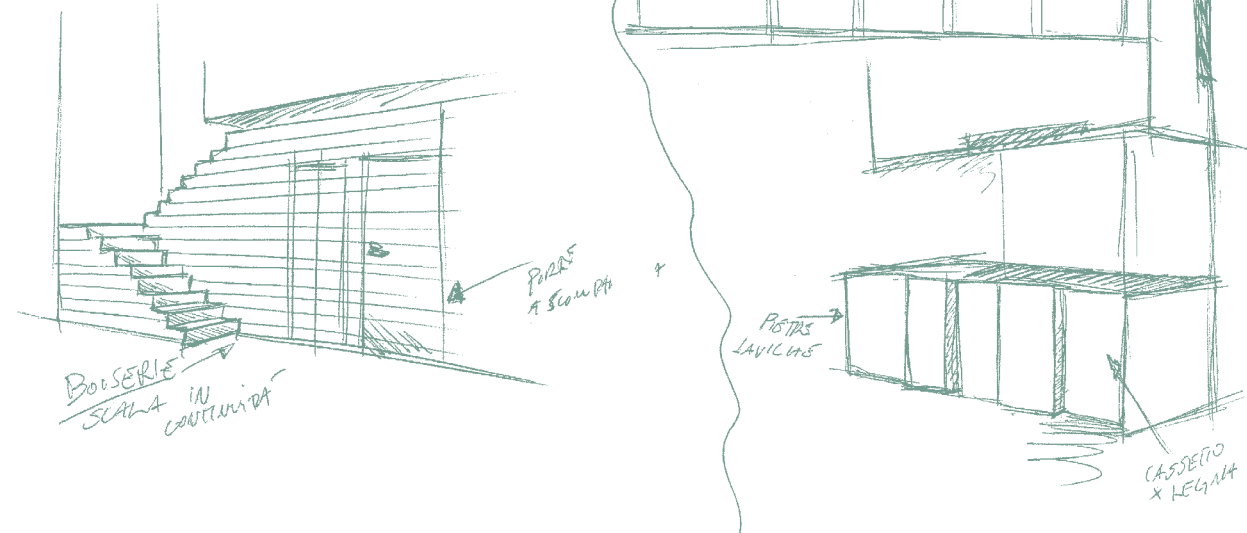





**3** SCEGLI IL SARTO MIGLIORE/  
CHOOSE THE BEST TAILOR



**PARTNER NEL  
DESIGN/  
DESIGN PARTNERS**

Costruiamo insieme nuove realizzazioni, partendo dalle tue intuizioni./

Together we produce new patterns, inspired by your intuition.

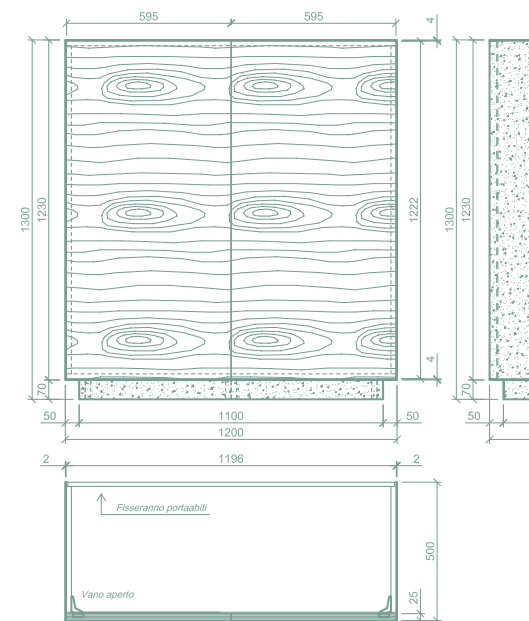

SEZ. ORIZZONTALE

PUSH & PU

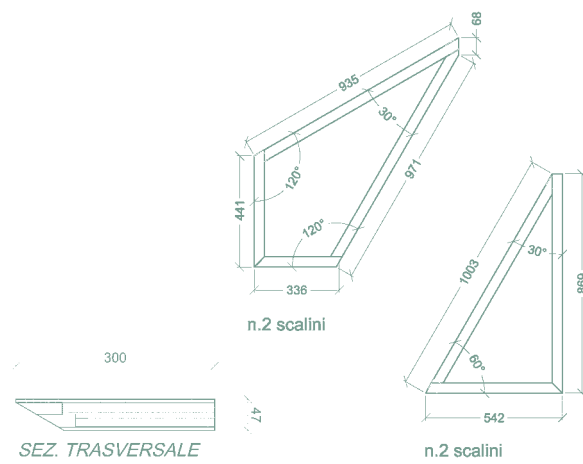

Siamo pronti a sostenere la tua voglia di ideare soluzioni progettuali innovative, accompagnandoti nelle fasi costruttive e mettendo a tua disposizione tutta l'esperienza del nostro laboratorio e del nostro ufficio tecnico./

We are ready to support your wish to create innovative projects and can be by your side during manufacture, placing all the experience of our laboratory and engineering office at your disposal.

MAESTRI ARTIGIANI:  
L'ECCELLENZA  
DELLE LAVORAZIONI  
MADE IN ITALY/  
MASTER CRAFTSMEN:  
THE EXCELLENCE  
OF MANUFACTURE MADE  
IN ITALY



Perfetti in ogni  
dettaglio, i tuoi  
progetti sapranno  
raccontare emozioni  
uniche, grazie  
a lavorazioni  
artigianali esclusive  
e ricercate, di  
altissima qualità,  
eseguite a mano  
dai nostri maestri  
artigiani./

Perfect in every  
detail, your projects  
will bring unique  
excitement, with the  
exclusive, refined  
craftsmanship of top  
quality, artisan made  
products.

LASCIA UN  
SEGNO NEL MONDO  
DEL DESIGN/  
MAKE YOUR MARK IN  
THE DESIGN WORLD

Le tue realizzazioni più prestigiose diventano capolavori di design, da mostrare con orgoglio. Come in un quadro d'autore, la tua firma impressa nel legno accresce il valore dell'opera e tramanda per sempre il tuo nome./

Your most prestigious creations become design masterpieces you will be proud to display. As in a famous painting, your signature stamped on the wood will increase the value of the work and carry on your name through time.

CPLAB DESIGN

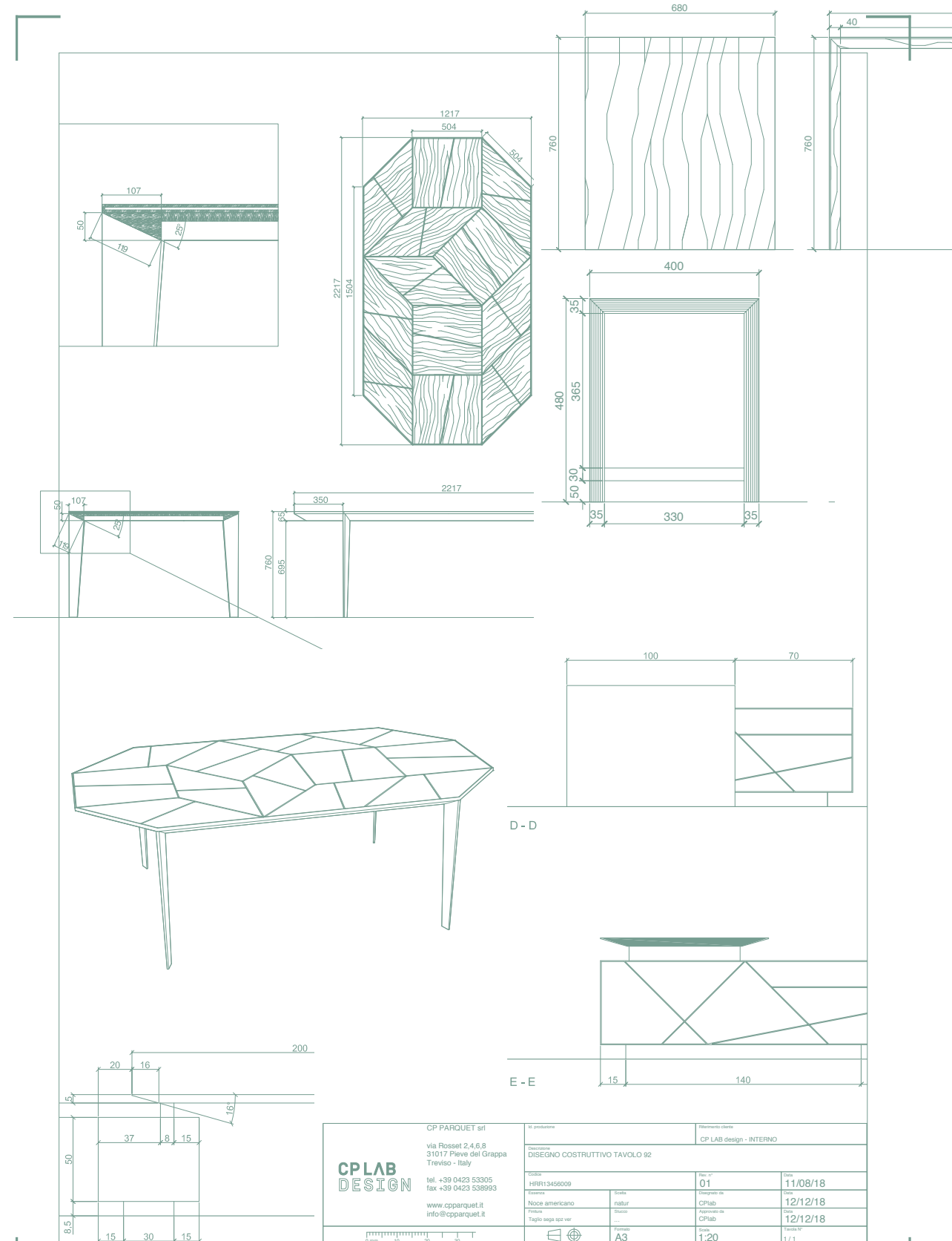

CP PARQUET srl via Rosset 2,4,6,8 31017 Pieve del Grappa Treviso - Italy tel. +39 0423 53305 fax +39 0423 538993 www.cpparquet.it info@cpparquet.it		Il produttore Riferimento cliente CP LAB design - INTERNO	
DESCRIZIONE DISEGNO COSTRUTTIVO TAVOLO 92			
Disegno HNRI13456009	Disegno natur	01	11/08/18
Materiali Noce americano	Disegno CPLab	12/12/18	12/12/18
Prodotto Taglio legno spm ser	Disegno CPLab	12/12/18	12/12/18
Formato A3		Scala 1:20	Foglio N° 1/1



**TAVOLO/TABLE 7**

Noce europeo rustico, spazzolato verniciato Natura. Gambe e piano in continuità di vena con bordo 16° gradi./ Rustic European walnut, brushed Natura varnished. Legs and top with same grain continuity and 16° edge.



**SCRIVANIA/DESK AM16**

Noce europeo rustico, spazzolato verniciato natura. Gamba e piano in continuità di vena con bordo 16° gradi e gamba/cassettiera a 6 cassette con frontali a tagli incrociati in noce 5 strati./Rustic European walnut, brushed Natura varnished. Leg and top with same grain continuity and 16° edge. Leg/drawer set with six drawers, five-layer, cross-cut walnut drawer fronts.



**TAVOLO/TABLE NATURA 2**

Rovere europeo rusticone, spazzolato verniciato Capri, piano composto da due tavole in rovere da 600 mm con bordo scortecciato e gambe in ferro nero verniciato trasparente./Rusticone European oak, brushed, distressed, Capri varnished. Top comprises 2 x 600mm oak boards with scraped edge and black painted iron legs.



**TAVOLO/TABLE TURTLE**

Rovere europeo rustico, spazzolato verniciato Caffè, piano in rovere con corona massiccia di sostegno e gambe in ferro nero verniciato trasparente./ Rustic European oak, brushed, Caffè varnished. Top in oak with solid crown support and transparent varnished black metal legs.

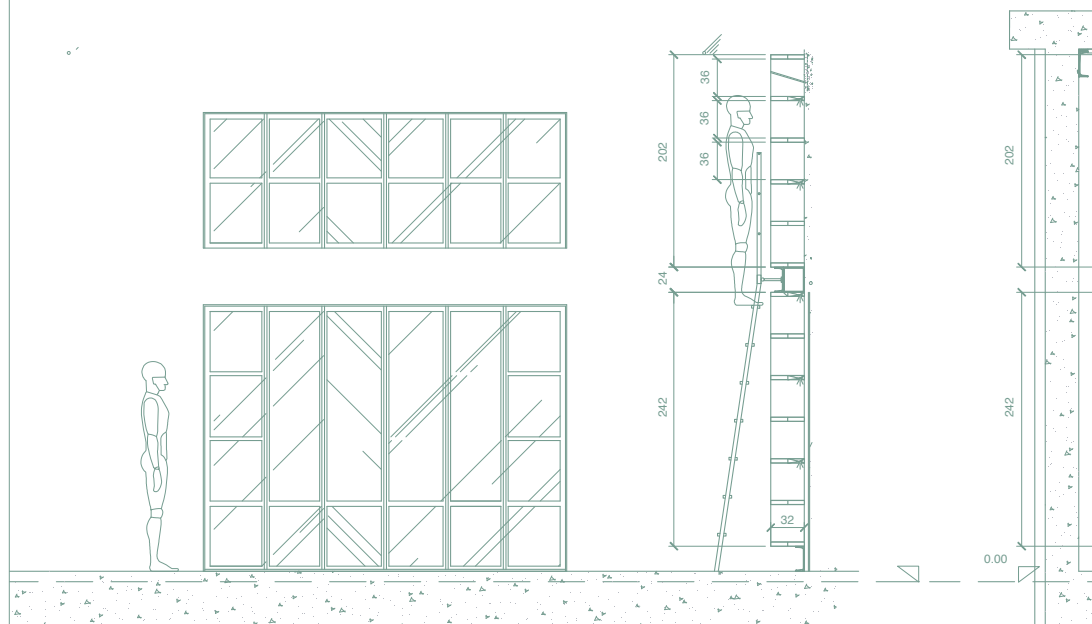
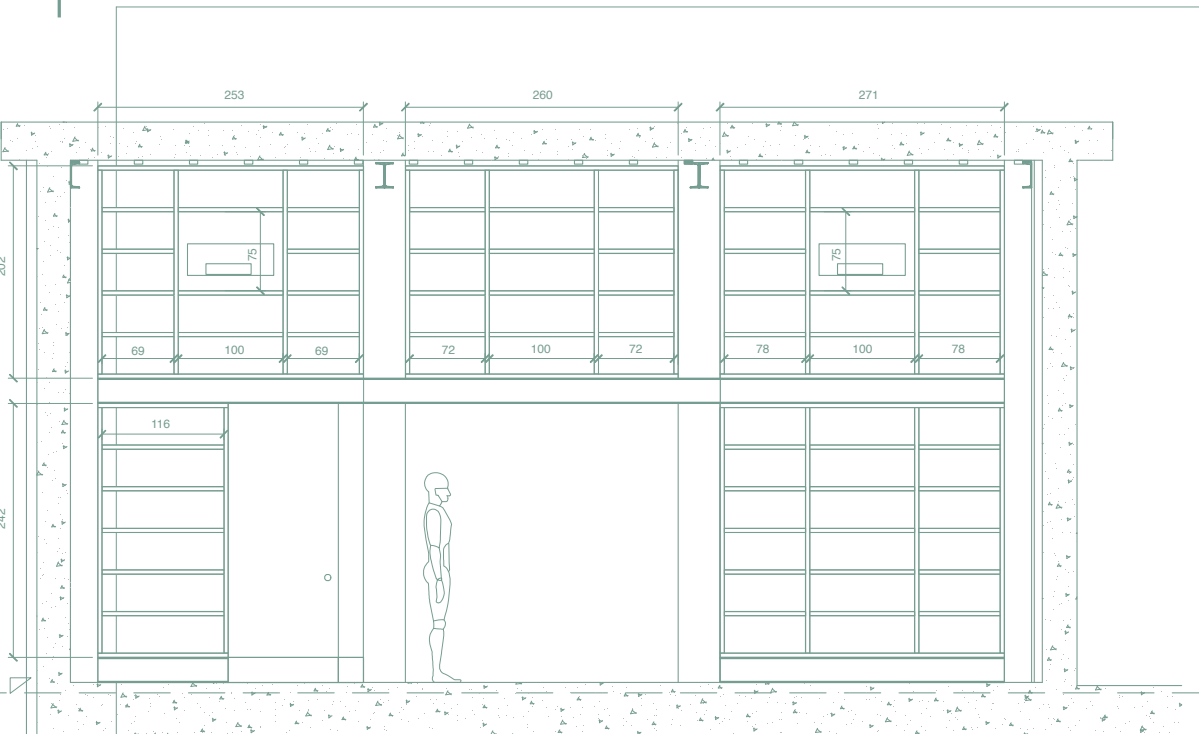

<b>CPLAB DESIGN</b> CP PARQUET srl via Rosset 24, 6/8 31017 Pieve del Grappa Treviso - Italy tel. +39 0423 53305 fax +39 0423 538993 www.cpparquet.it info@cpparquet.it	IT produzione Disegnato <b>DISEGNO COSTRUTTIVO LIBRERIA SOSPESA</b>	Sistema classe CP LAB design - LO	Rev. n° <b>04</b>	Data <b>2/2/19</b>
	Codice HDD100434	Specie Noce americano	Disegnato da CPlab	Data <b>2/2/19</b>
	Finiture BRZ vin	Classe A3	Supervisato da CPlab	Data <b>2/2/19</b>
	Scale 1:20	Foglio n° 1 / 1		

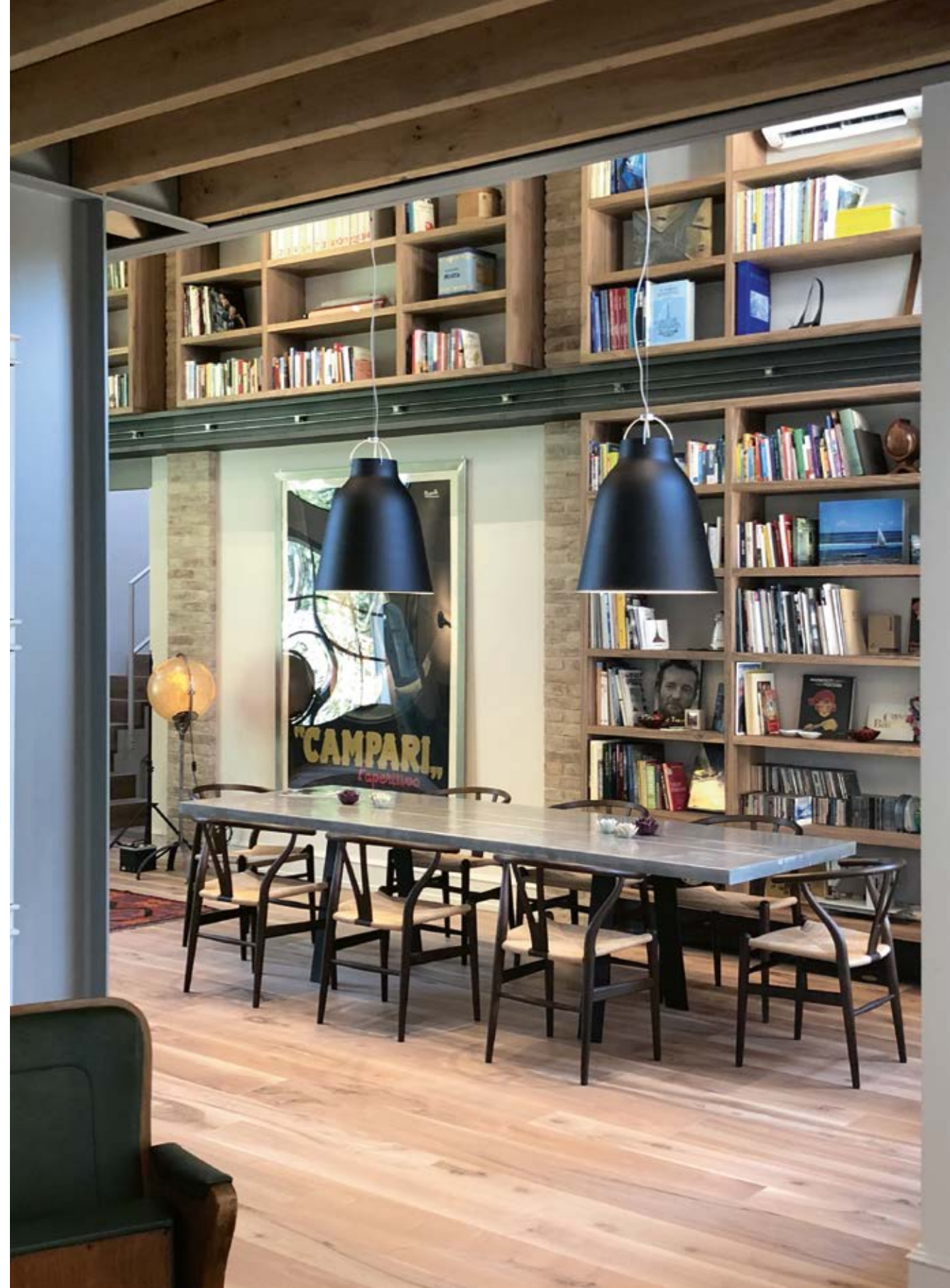



Librerie sospese e scala scorrevole in noce americano natur, pavimento noce europeo rustico e piano snack cucina in rovere europeo rusticone. Progetto a cura di: Architetto Franco Biagiotti - Interior designer Monica Poletti / Suspended bookcases and sliding ladder in Natur American walnut, rustic European walnut flooring, and kitchen snack counter in rusticone European oak. Project by: Arch. Franco Biagiotti - Interior Designer Monica Poletti









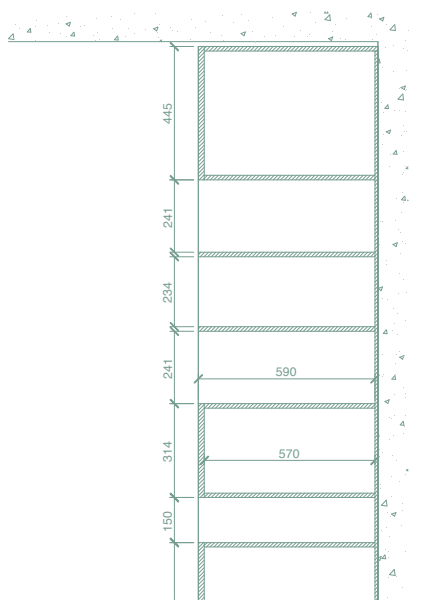
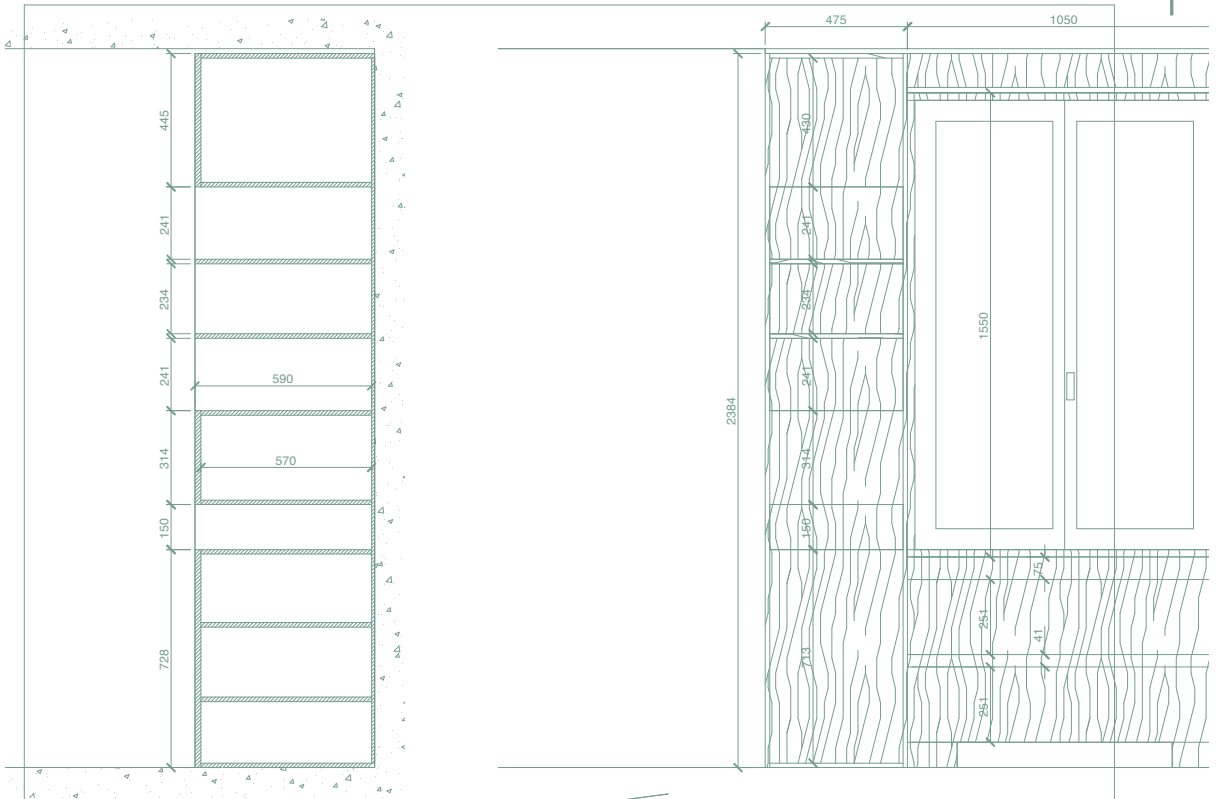

<b>CPLAB DESIGN</b> CP PARQUET srl via Rosset 2, 4, 6, 8 31017 Pieve del Grappa Treviso - Italy tel. +39 0423 53305 fax +39 0423 538993 www.cpparquet.it info@cpparquet.it	In produzione CP LAB design - VL	
	Descrizione DISEGNO COSTRUTTIVO LIBRERIA VLASTIMIR	
Codice HWW15608900	Data 02	Data 12/10/17
Fornitore ROVERE EUROPEO RUSTICO	Stile Rustico	Disegnato da CPLAB
Finestra Spazzolato opaco bianco	Colore marrone	Verificato da CPLAB
	Formato A3	Data 12/10/17
	Scala 1:20	Foglio N° 1 / 1





Rivestimento a parete e libreria/  
contenitore in rovere europeo  
rustico spazzolato oliato bianco.  
Rivestimento a parete in Antico  
Asolo 3 strati.  
Progetto a cura di: Designer  
Svitlana Shakhnovska, Studio NLO  
Design, Kiev.  
Wall cladding and bookcase/  
storage unit in rustic European  
oak, brushed and oiled white.  
Three-layer Antico Asolo wall  
cladding.  
Project by: Designer Svitlana  
Shakhnovska, Studio NLO Design,  
Kiev.

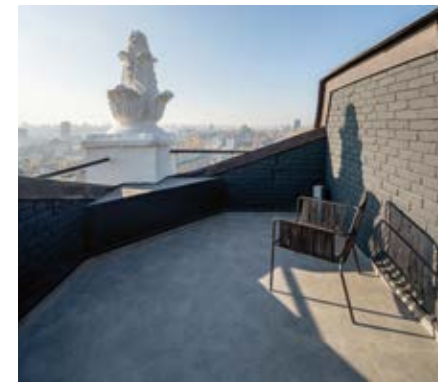



## NATURALE BELLEZZA/ NATURAL BEAUTY

Un'anima verde, in equilibrio con l'ambiente, distingue i nostri progetti, creati con attenzione alla sostenibilità, usando vero legno, verniciature all'acqua, oliature naturali, colle amiche dell'uomo e dell'ecosistema./

A green soul in harmony with the environment distinguishes our projects, carefully created to be sustainable, using real wood, treated with water-based varnishes, natural oils and eco-friendly adhesives.



# CP PARQUET

CP PARQUET srl  
Pieve del Grappa · Treviso · Italy  
Tel. +39 0423 53305  
info@cparquet.it

www.cparquet.it    made in italy

Showroom c/o Agape12 Concept Store  
Via Statuto 12 Milano



# CP PARQUET

CP PARQUET srl  
Pieve del Grappa · Treviso · Italy  
Tel. +39 0423 53305  
info@cparquet.it

www.cparquet.it    made in italy

Showroom c/o Agape12 Concept Store  
Via Statuto 12 Milano